

Auxiliary Powered, Strain Gauge Conditioner

STG



The STG converts the signal generated by a resistance bridge strain gauge to a standard analogue signal format.

- Remote sensing bridge power supply provides highly stable excitation voltage
- Can power bridges up to $4 \times 350 \Omega$ at 10V
- Tare adjustment and test points to correct for initial loading
- Front panel adjustment and test points accurately set the bridge excitation voltage
- Highly accurate (0.1% of span)
- LED power indication
- AC or DC powered
- Removable, screw-type, terminal blocks
- Compact metal housing



Australia

Weidmüller Pty Ltd.
43 Huntingwood Drive, Huntingwood
NSW 2148
Phone +61 (0) 2 9671 9999
Fax +61 (0) 2 9671 9900
Info@weidmuller.com.au
www.mannindustries.com.au

United Kingdom







Weidmüller Ltd.
1 Abbey Wood Road, Kings Hill
West Malling, Kent ME19 4YT
Phone +44 1732-877032
Fax +44 1732-873873
Info@weidmuller.co.uk
www.weidmueller.com

Other countries

Weidmüller Interface GmbH & Co.
Postfach 3030
32720 Detmold
Phone +495231-14-0
Fax +495231-14-2083
info@weidmueller.com
www.weidmueller.com

STG Strain Gauge Conditioner

General Technical Data

Input					
Type	Resistance bridge strain gauge				
Input span ranges	1mV to 700mV				
Input impedance	1MΩ				
Bridge excitation voltage					
Type	Remote sensing				
Excitation voltage	5V or 10V				
Ripple	less than 10mV p/p at full load				
Drive capability	120mA @ 10V (equivalent to 4 x 350Ω loadcells @ 10V)				
Output					
Type	4-20mA, 0-20mA and 1-5V (selected by push-fit jumpers)				
Current ranges	0-20mA, 4-20mA into 0-1KΩ load				
Voltage ranges	0-5Vdc, 0-10Vdc, 1-5Vdc (true voltage source to 20mA)				
Ripple	< 20mV peak to peak at maximum load and span				
Power supply					
Type	AC or DC powered (as ordered)				
AC	110Vac at 47-63Hz (permissible range 100-132Vac) 240Vac at 47-63Hz (permissible range 200-264Vac)				
DC	24Vdc (permissible range 20-28Vdc)				
Power Usage	AC 3VA or 3W at 24Vdc				
Adjustments					
Type	20-turn potentiometers				
Span	45-105% of nominal span				
Zero	±10% of nominal span				
Tare	±100% or 0-200% of input span				
Bridge excitation	±10% of nominal voltage				
General					
Linearity	Typically ±0.05% of span				
Repeatability	±0.05% of span				
Temperature drift	Typically 0.02% span/°C				
Long term drift	0.1% per 10,000 hours				
Frequency response	-3dB point = 5Hz, optional 1KHz				
Response time	200 mS for 10-90% output change, optional 1ms				
Insulation Co-ordination					
Ports	Input & Output / Power Supply / Case				
Rated Insulation Voltage	300Vrms				
Overvoltage Category	III				
Impulse Withstand	4kV (1.2 / 50)				
Isolation	2 kV (between ports)				
Environmental Conditions					
Operating temperature	0 to 60 °C				
Storage temperature	-25 to +70 °C				
Pollution Degree	2				
Relative humidity	10-90% (non-condensing)				
Housing					
Type	Anodised Aluminium Enclosure with protective earth				
Dimensions	See diagram				
Weight	0.45Kg				
Connection type	Plug in terminal blocks with screw connections				
Approvals					
STG (DC powered only)	<table border="1"> <tr> <td></td> <td>E256486</td> </tr> <tr> <td></td> <td>LV Directive EMC</td> </tr> </table>		E256486		LV Directive EMC
	E256486				
	LV Directive EMC				
Standard					
CAN/CSA C22.2 No. 1010.1:92 UL61010-1: 2004					
EN50178:1998 BS EN 61326:1998 + A2					



Connections

Terminal	Signal	
1	Sense -	Bridge Excitation Voltage
2	Sense +	
3	Excitation +	
4	Excitation -	
5	Not Used	
6	Not Used	
7	Signal +	Input signal
8	Signal -	
9	Not Used	
10	Neutral (-)	Power Supply
11	Live (+)	
12	Not Used	
13	Output +	Output signal
14	Output -	
15	Not Used	
16	Not Used	
Case	Earthing is via a stud on lower side of case	

Note: only the power supply is isolated.

Dimension drawing

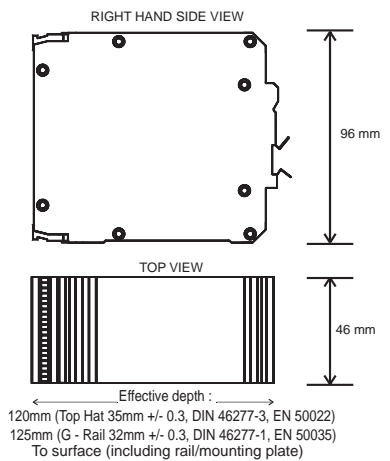

Ordering Information

Type	Cat. No.
(Model 1/2/3/4 - See key below)	
STG 10V/2mV/V/4-20mA/24Vdc	7940011671

Note: For other ranges please specify STG/1/2/3/4 where:
1 - Bridge excitation voltage
2 - Bridge sensitivity
3 - Output signal format
4 - Power supply voltage