

## PRO-H Series Single-Phase Power Supplies

# NEW



The PRO-H Series is a new generation of high performance DIN-rail mounted single-phase power supplies designed to work reliably even under demanding factory floor conditions. A high power reserve guarantees reliable start-up of loads with high inrush currents. Excellent electrical specifications and high immunity against fluctuations on input voltage makes these compact modules the best choice to power sensitive loads in industrial process control systems, machine tools or other demanding industrial applications. The PRO-H Series offers users easy installation with detachable screw terminal block and snap-on mounting on DIN-rails. All models offer a

DC-OK signal and external shut down function. Redundant operation with true power sharing is available as an option.

The PRO-H Series power supplies comply with the latest safety and EMC standards for industrial environments.

- Hazardous approvals for process automation applications
- Industrial grade design
- Rugged metal case for harsh industrial environments
- Autoselect input and international safety approvals
- Industrial operating temperature range:  $-25^{\circ}\text{C}$  to  $+70^{\circ}\text{C}$  (Cold start at full load at  $-25^{\circ}\text{C}$ )
- Variable output voltage
- Indefinite short circuit, overvoltage and overtemperature protection
- Power OK signal
- Remote On/Off
- Shock and vibration proof
- Optional panel mounting
- Redundancy module

**Weidmüller, Canada**  
10 Spy Court  
Markham, Ontario L3R 5H6  
Telephone: (800) 268-4080  
Facsimile: (877) 300-5635  
Email: [info1@weidmuller.ca](mailto:info1@weidmuller.ca)  
Website: [www.weidmuller.ca](http://www.weidmuller.ca)

**Weidmüller, Mexico**  
Blvd. Hermanos Serdán 698,  
Col. San Rafael Oriente  
Puebla, Puebla, Mexico  
C.P. 72029  
Telephone: 01 222 2686267  
Facsimile: 01 222 2686219  
Email: [clientes@weidmuller.com.mx](mailto:clientes@weidmuller.com.mx)  
Website: [www.weidmuller.com.mx](http://www.weidmuller.com.mx)

**Weidmüller, United States**  
821 Southlake Blvd.  
Richmond, Virginia 23236  
Telephone: (800) 849-9343  
Facsimile: (804) 379-2593  
Email: [info@weidmuller.com](mailto:info@weidmuller.com)  
Website: [www.weidmuller.com](http://www.weidmuller.com)

**Weidmüller** 

CP T SNT 70W 12V 6A

CP T SNT 140W 12V 12A

CP T SNT 90W 24V 3.8A

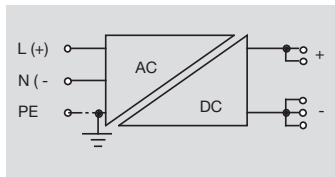

Technical Data

Input Specifications

Input voltage	115VAC/230VAC autoselect
Input voltage range	85-132/187-264 VAC autoselect (output current derating below 100VAC)*
Input voltage frequency	47Hz - 63Hz
Harmonic limits	EN 61000-3-2, Class A (for limited output power)
Hold up time	20ms min. 115/230 VAC
Inrush current	<12A @ 115VAC; <20A @ 230VAC
Recommended Circuit breaker, Curve 1 or fuse, slow blow type	6A
Efficiency	87% typ.

Output Specifications

Output voltage	12 VDC
Output voltage adj. range	12-14 VDC
Output current	6.5A
Output power max.	70W
Regulation – Input variation	0.5 % max.
– Load variation (10–100 %)	0.5 % max.
Ripple and Noise (20MHz Bandwidth)	100 mV pk-pk typ. (200 mV pk-pk max. at I <sub>max</sub> )
Electronic short circuit protection	Current limitation at I <sub>max</sub> , constant current, automatic recovery
Output overvoltage protection	20V
Overload protection	electronic overload protection
Overtemperature protection	Switch off at overtemperature, automatic restart
Status indicator	Dual color LED (green: DC ok; red: DC off)
Power OK signal – trigger threshold:	9–11 V
– active output signal: (reference to –Vout)	11.0 V ±1.0 V (20 mA max.)
– relay output	rated: 30 VDC/1.0 A

General Specifications

Operating temperature range	–25 °C to +70 °C max. (–13 °F to +158°F)**
Cooling	convection cooling, no internal fan
Mounting	TS35 DIN-rail (Horizontal) to allow for cooling
Storage temperature	–25 °C to +85 °C (–13°F to +185°F)
Humidity (non condensing)	95 % rel. H max.
Pollution degree	2
Temperature coefficient	0.02 %/K
Reliability, calculated MTBF @ 25°C acc. to IEC 61709	>1.8 Million hours, max. load
Remote On/Off	by ext. contact.

(See LIT0917 - Installation Instructions)

Isolation	DC on: -S contact open DC off: -S connected via 1Kohm to -Vout according to IEC/EN 60950-1, UL 60950-1, UL 508
Environment – Vibration acc. IEC 60068-2-6; – Shock acc. IEC 60068-2-27	3 axis, sine sweep, 10–55 Hz, 1 g, 1 oct/min 3 axis, 15 g half sine, 11 ms
Dimension (W x D x H)	35 x 110 x 110 mm
Clearances – Above/Below – Sides	80 mm (3.15 in) 10 mm (0.39 in)
Weight	0.5kg

Approvals

See Approvals Table, page 6

Input voltage	115VAC/230VAC autoselect
Input voltage range	85-132/187-264 VAC autoselect (output current derating below 100VAC)*
Input voltage frequency	47Hz - 63Hz
Harmonic limits	EN 61000-3-2, Class A (for limited output power)
Hold up time	20ms min. 115/230 VAC
Inrush current	<13A @ 115VAC; <25A @ 230VAC
Recommended Circuit breaker, Curve 1 or fuse, slow blow type	6A
Efficiency	87% typ.

Output voltage	12 VDC
Output voltage adj. range	12-14 VDC
Output current	13.0A
Output power max.	140W
Regulation – Input variation	0.5 % max.
– Load variation (10–100 %)	0.5 % max.
Ripple and Noise (20MHz Bandwidth)	100 mV pk-pk typ. (200 mV pk-pk max. at I <sub>max</sub> )
Electronic short circuit protection	Current limitation at I <sub>max</sub> , constant current, automatic recovery
Output overvoltage protection	20V
Overload protection	electronic overload protection
Overtemperature protection	Switch off at overtemperature, automatic restart
Status indicator	Dual color LED (green: DC ok; red: DC off)
Power OK signal – trigger threshold:	9–11 V
– active output signal: (reference to –Vout)	11.0 V ±1.0 V (20 mA max.)
– relay output	rated: 30 VDC/1.0 A

Operating temperature range	–25 °C to +70 °C max. (–13 °F to +158°F)**
Cooling	convection cooling, no internal fan
Mounting	TS35 DIN-rail (Horizontal) to allow for cooling
Storage temperature	–25 °C to +85 °C (–13°F to +185°F)
Humidity (non condensing)	95 % rel. H max.
Pollution degree	2
Temperature coefficient	0.02 %/K
Reliability, calculated MTBF @ 25°C acc. to IEC 61709	>1.2 Million hours, max. load
Remote On/Off	by ext. contact.

(See LIT0917 - Installation Instructions)

Isolation	DC on: -S contact open DC off: -S connected via 1Kohm to -Vout according to IEC/EN 60950-1, UL 60950-1, UL 508
Environment – Vibration acc. IEC 60068-2-6; – Shock acc. IEC 60068-2-27	3 axis, sine sweep, 10–55 Hz, 1 g, 1 oct/min 3 axis, 15 g half sine, 11 ms
Dimension (W x D x H)	54 x 110 x 110 mm
Clearances – Above/Below – Sides	80 mm (3.15 in) 10 mm (0.39 in)
Weight	0.7kg

See Approvals Table, page 6

Input voltage	115VAC/230VAC autoselect
Input voltage range	85-132/187-264 VAC autoselect (output current derating below 100VAC)*
Input voltage frequency	47Hz - 63Hz
Harmonic limits	EN 61000-3-2, Class A (for limited output power)
Hold up time	20ms min. 115/230 VAC
Inrush current	<12A @ 115VAC; <20A @ 230VAC
Recommended Circuit breaker, Curve 1 or fuse, slow blow type	6A
Efficiency	87% typ.

Output voltage	24 VDC
Output voltage adj. range	24-28 VDC
Output current	3.75A
Output power max.	90W
Regulation – Input variation	0.5 % max.
– Load variation (10–100 %)	0.5 % max.
Ripple and Noise (20MHz Bandwidth)	100 mV pk-pk typ. (200 mV pk-pk max. at I <sub>max</sub> )
Electronic short circuit protection	Current limitation at I <sub>max</sub> , constant current, automatic recovery
Output overvoltage protection	35V
Overload protection	electronic overload protection
Overtemperature protection	Switch off at overtemperature, automatic restart
Status indicator	Dual color LED (green: DC ok; red: DC off)
Power OK signal – trigger threshold:	18-22 V
– active output signal: (reference to –Vout)	22.0 V ±2.0 V (10 mA max.)
– relay output	rated: 30 VDC/1.0 A

Operating temperature range	–25 °C to +70 °C max. (–13 °F to +158°F)**
Cooling	convection cooling, no internal fan
Mounting	TS35 DIN-rail (Horizontal) to allow for cooling
Storage temperature	–25 °C to +85 °C (–13°F to +185°F)
Humidity (non condensing)	95 % rel. H max.
Pollution degree	2
Temperature coefficient	0.02 %/K
Reliability, calculated MTBF @ 25°C acc. to IEC 61709	>1.8 Million hours, max. load
Remote On/Off	by ext. contact.

(See LIT0917 - Installation Instructions)

Isolation	DC on: -S contact open DC off: -S connected via 1Kohm to -Vout according to IEC/EN 60950-1, UL 60950-1, UL 508
Environment – Vibration acc. IEC 60068-2-6; – Shock acc. IEC 60068-2-27	3 axis, sine sweep, 10–55 Hz, 1 g, 1 oct/min 3 axis, 15 g half sine, 11 ms
Dimension (W x D x H)	35 x 110 x 110 mm
Clearances – Above/Below – Sides	80 mm (3.15 in) 10 mm (0.39 in)
Weight	0.5kg

See Approvals Table, page 6

Ordering Data

Type	Part No.
CP T SNT 70W 12V 6A	1105430000

Type	Part No.
CP T SNT 140W 12V 12A	1105440000

Type	Part No.
CP T SNT 90W 24V 3.8A	1105790000

\* See Graph B, page 8

\*\*See Graph A, page 8

CP T SNT 180W 24V 7.5A

CP T SNT 360W 24V 15A

CP T SNT 600W 24V 25A

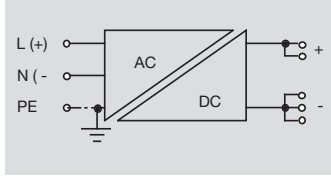

## Technical Data

Input Specifications	CP T SNT 180W 24V 7.5A	CP T SNT 360W 24V 15A	CP T SNT 600W 24V 25A
Input voltage	115VAC/230VAC autoselect	115VAC/230VAC autoselect	115VAC/230VAC autoselect
Input voltage range	85-132/187-264 VAC autoselect (output current derating below 100VAC)*	85-132/187-264 VAC autoselect (output current derating below 100VAC)*	85-132/187-264 VAC autoselect (output current derating below 100VAC)*
Input voltage frequency	47Hz - 63Hz	47Hz - 63Hz	47Hz - 63Hz
Harmonic limits	EN 61000-3-2, Class A (for limited output power)	EN 61000-3-2, Class A (for limited output power)	EN 61000-3-2, Class A (for limited output power)
Hold up time	20ms min. 115/230 VAC	20ms min. 115/230 VAC	20ms min. 115/230 VAC
Inrush current	<13A @ 115VAC; <25A @ 230VAC	<16A @ 115VAC; <25A @ 230VAC	<25A @ 115VAC; <30A @ 230VAC
Recommended Circuit breaker, Curve 1 or fuse, slow blow type	6A	10A	15A
Efficiency	87% typ.	87% typ.	87% typ.
Output Specifications			
Output voltage	24 VDC	24 VDC	24 VDC
Output voltage adj. range	24-28 VDC	24-28 VDC	24-28 VDC
Output current	7.5A	15A	25A
Output power max.	180W	360W	600W
Regulation – Input variation	0.5 % max.	0.5 % max.	0.5 % max.
– Load variation (10–100 %)	0.5 % max.	0.5 % max.	0.5 % max.
Ripple and Noise (20MHz Bandwidth)	100 mV pk-pk typ. (200 mV pk-pk max. at I <sub>max</sub> )	100 mV pk-pk typ. (200 mV pk-pk max. at I <sub>max</sub> )	100 mV pk-pk typ. (200 mV pk-pk max. at I <sub>max</sub> )
Electronic short circuit protection	Current limitation at I <sub>max</sub> , constant current, automatic recovery	Current limitation at I <sub>max</sub> , constant current, automatic recovery	Current limitation at I <sub>max</sub> , constant current, automatic recovery
Output overvoltage protection	35V	35V	35V
Overload protection	electronic overload protection	electronic overload protection	electronic overload protection
Overtemperature protection	Switch off at overtemperature, automatic restart	Switch off at overtemperature, automatic restart	Switch off at overtemperature, automatic restart
Status indicator	Dual color LED (green: DC ok; red: DC off)	Dual color LED (green: DC ok; red: DC off)	Dual color LED (green: DC ok; red: DC off)
Power OK signal – trigger threshold:	18-22 V	18-22 V	18-22 V
– active output signal: (reference to -Vout)	22.0 V ±2.0 V (20 mA max.)	22.0 V ±2.0 V (20 mA max.)	22.0 V ±2.0 V (20 mA max.)
– relay output	rated: 30 VDC/1.0 A	rated: 30 VDC/1.0 A	rated: 30 VDC/1.0 A
General Specifications			
Operating temperature range	-25 °C to +70 °C max. (-13 °F to +158°F)**	-25 °C to +70 °C max. (-13 °F to +158°F)**	-25 °C to +70 °C max. (-13 °F to +158°F)**
Cooling	convection cooling, no internal fan	convection cooling, no internal fan	convection cooling, no internal fan
Mounting	TS35 DIN-rail (Horizontal) to allow for cooling	TS35 DIN-rail (Horizontal) to allow for cooling	TS35 DIN-rail (Horizontal) to allow for cooling
Storage temperature	-25 °C to +85 °C (- 13°F to +185°F)	-25 °C to +85 °C (- 13°F to +185°F)	-25 °C to +85 °C (- 13°F to +185°F)
Humidity (non condensing)	95 % rel. H max.	95 % rel. H max.	95 % rel. H max.
Pollution degree	2	2	2
Temperature coefficient	0.02 %/K	0.02 %/K	0.02 %/K
Reliability, calculated MTBF @ 25°C acc. to IEC 61709	>0.9 Million hours, max. load	>0.9 Million hours, max. load	>0.9 Million hours, max. load
Remote On/Off	by ext. contact.	by ext. contact.	by ext. contact.
(See LIT0917 - Installation Instructions)	DC on: -S contact open	DC on: -S contact open	DC on: -S contact open
Isolation	DC off: -S connected via 1Kohm to -Vout according to IEC/EN 60950-1, UL 60950-1, UL 508	DC off: -S connected via 1Kohm to -Vout according to IEC/EN 60950-1, UL 60950-1, UL 508	DC off: -S connected via 1Kohm to -Vout according to IEC/EN 60950-1, UL 60950-1, UL 508
Environment – Vibration acc. IEC 60068-2-6;	3 axis, sine sweep, 10–55 Hz, 1 g, 1 oct/min	3 axis, sine sweep, 10–55 Hz, 1 g, 1 oct/min	3 axis, sine sweep, 10–55 Hz, 1 g, 1 oct/min
– Shock acc. IEC 60068-2-27	3 axis, 15 g half sine, 11 ms	3 axis, 15 g half sine, 11 ms	3 axis, 15 g half sine, 11 ms
Dimension (W x D x H)	54 x 110 x 110 mm	80 x 125 x 125 mm	165 x 125 x 125 mm
Clearances – Above/Below	80 mm (3.15 in)	80 mm (3.15 in)	80 mm (3.15 in)
– Sides	10 mm (0.39 in)	10 mm (0.39 in)	10 mm (0.39 in)
Weight	0.7kg	1.1kg	2.8kg
Approvals	See Approvals Table, page 6	See Approvals Table, page 6	See Approvals Table, page 6

## Ordering Data

Type	Part No.	Type	Part No.	Type	Part No.
CP T SNT 180W 24V 7.5A	1105810000	CP T SNT 360W 24V 15A	1105820000	CP T SNT 600W 24V 25A	1105840000

\* See Graph B, page 8

\*\*See Graph A, page 8

CP T SNT 180W 48V 4A

CP T SNT 360W 48V 7.5A

CP T SNT 600W 48V 12.5A

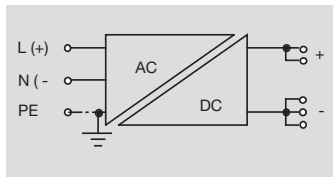

Technical Data

Input Specifications

Input voltage	115VAC/230VAC autoselect
Input voltage range	85-132/187-264 VAC autoselect (output current derating below 100VAC)*
Input voltage frequency	47Hz - 63Hz
Harmonic limits	EN 61000-3-2, Class A (for limited output power)
Hold up time	20ms min. 115/230 VAC
Inrush current	<13A @ 115VAC; <25A @ 230VAC
Recommended Circuit breaker, Curve 1 or fuse, slow blow type	6A
Efficiency	87% typ.

Output Specifications

Output voltage	48 VDC
Output voltage adj. range	48-56 VDC
Output current	4.0A
Output power max.	180W
Regulation – Input variation	0.5 % max.
– Load variation (10–100 %)	0.5 % max.
Ripple and Noise (20MHz Bandwidth)	100 mV pk-pk typ. (200 mV pk-pk max. at I <sub>max</sub> )
Electronic short circuit protection	Current limitation at I <sub>max</sub> ., constant current, automatic recovery
Output overvoltage protection	60V
Overload protection	electronic overload protection
Overtemperature protection	Switch off at overtemperature, automatic restart
Status indicator	Dual color LED (green: DC ok; red: DC off)
Power OK signal – trigger threshold:	36-46 V
– active output signal: (reference to –Vout)	44.0 V ±4.0 V (15 mA max.)
– relay output	rated: 48 VDC/0.5 A

General Specifications

Operating temperature range	–25 °C to +70 °C max. (–13 °F to +158°F)**
Cooling	convection cooling, no internal fan
Mounting	TS35 DIN-rail (Horizontal) to allow for cooling
Storage temperature	–25 °C to +85 °C (– 13°F to +185°F)
Humidity (non condensing)	95 % rel. H max.
Pollution degree	2
Temperature coefficient	0.02 %/K
Reliability, calculated MTBF @ 25°C acc. to IEC 61709	>0.9 Million hours, max. load
Remote On/Off	by ext. contact.
(See LIT0917 - Installation Instructions)	DC on: -S contact open
Isolation	DC off: -S connected via 1Kohm to -Vout according to IEC/EN 60950-1, UL 60950-1, UL 508
Environment – Vibration acc. IEC 60068-2-6;	3 axis, sine sweep, 10–55 Hz, 1 g, 1 oct/min
– Shock acc. IEC 60068-2-27	3 axis, 15 g half sine, 11 ms
Dimension (W x D x H)	54 x 110 x 110 mm
Clearances – Above/Below	80 mm (3.15 in)
– Sides	10 mm (0.39 in)
Weight	0.7kg

Approvals

See Approvals Table, page 6

Input voltage	115VAC/230VAC autoselect
Input voltage range	85-132/187-264 VAC autoselect (output current derating below 100VAC)*
Input voltage frequency	47Hz - 63Hz
Harmonic limits	EN 61000-3-2, Class A (for limited output power)
Hold up time	20ms min. 115/230 VAC
Inrush current	<16A @ 115VAC; <25A @ 230VAC
Recommended Circuit breaker, Curve 1 or fuse, slow blow type	10A
Efficiency	87% typ.

Output voltage	48 VDC
Output voltage adj. range	48-56 VDC
Output current	7.5A
Output power max.	360W
Regulation – Input variation	0.5 % max.
– Load variation (10–100 %)	0.5 % max.
Ripple and Noise (20MHz Bandwidth)	100 mV pk-pk typ. (200 mV pk-pk max. at I <sub>max</sub> )
Electronic short circuit protection	Current limitation at I <sub>max</sub> ., constant current, automatic recovery
Output overvoltage protection	60V
Overload protection	electronic overload protection
Overtemperature protection	Switch off at overtemperature, automatic restart
Status indicator	Dual color LED (green: DC ok; red: DC off)
Power OK signal – trigger threshold:	36-46 V
– active output signal: (reference to –Vout)	44.0 V ±4.0 V (15 mA max.)
– relay output	rated: 48 VDC/0.5 A

Operating temperature range	–25 °C to +70 °C max. (–13 °F to +158°F)**
Cooling	convection cooling, no internal fan
Mounting	TS35 DIN-rail (Horizontal) to allow for cooling
Storage temperature	–25 °C to +85 °C (– 13°F to +185°F)
Humidity (non condensing)	95 % rel. H max.
Pollution degree	2
Temperature coefficient	0.02 %/K
Reliability, calculated MTBF @ 25°C acc. to IEC 61709	>0.9 Million hours, max. load
Remote On/Off	by ext. contact.
(See LIT0917 - Installation Instructions)	DC on: -S contact open
Isolation	DC off: -S connected via 1Kohm to -Vout according to IEC/EN 60950-1, UL 60950-1, UL 508
Environment – Vibration acc. IEC 60068-2-6;	3 axis, sine sweep, 10–55 Hz, 1 g, 1 oct/min
– Shock acc. IEC 60068-2-27	3 axis, 15 g half sine, 11 ms
Dimension (W x D x H)	80 x 125 x 125 mm
Clearances – Above/Below	80 mm (3.15 in)
– Sides	10 mm (0.39 in)
Weight	1.1kg

See Approvals Table, page 6

Input voltage	115VAC/230VAC autoselect
Input voltage range	85-132/187-264 VAC autoselect (output current derating below 100VAC)*
Input voltage frequency	47Hz - 63Hz
Harmonic limits	EN 61000-3-2, Class A (for limited output power)
Hold up time	20ms min. 115/230 VAC
Inrush current	<25A @ 115VAC; <30A @ 230VAC
Recommended Circuit breaker, Curve 1 or fuse, slow blow type	15A
Efficiency	87% typ.

Output voltage	48 VDC
Output voltage adj. range	48-56 VDC
Output current	12.5A
Output power max.	600W
Regulation – Input variation	0.5 % max.
– Load variation (10–100 %)	0.5 % max.
Ripple and Noise (20MHz Bandwidth)	100 mV pk-pk typ. (200 mV pk-pk max. at I <sub>max</sub> )
Electronic short circuit protection	Current limitation at I <sub>max</sub> ., constant current, automatic recovery
Output overvoltage protection	60V
Overload protection	electronic overload protection
Overtemperature protection	Switch off at overtemperature, automatic restart
Status indicator	Dual color LED (green: DC ok; red: DC off)
Power OK signal – trigger threshold:	36-46 V
– active output signal: (reference to –Vout)	44.0 V ±4.0 V (15 mA max.)
– relay output	rated: 48 VDC/0.5 A

Operating temperature range	–25 °C to +70 °C max. (–13 °F to +158°F)**
Cooling	convection cooling, no internal fan
Mounting	TS35 DIN-rail (Horizontal) to allow for cooling
Storage temperature	–25 °C to +85 °C (– 13°F to +185°F)
Humidity (non condensing)	95 % rel. H max.
Pollution degree	2
Temperature coefficient	0.02 %/K
Reliability, calculated MTBF @ 25°C acc. to IEC 61709	>0.9 Million hours, max. load
Remote On/Off	by ext. contact.
(See LIT0917 - Installation Instructions)	DC on: -S contact open
Isolation	DC off: -S connected via 1Kohm to -Vout according to IEC/EN 60950-1, UL 60950-1, UL 508
Environment – Vibration acc. IEC 60068-2-6;	3 axis, sine sweep, 10–55 Hz, 1 g, 1 oct/min
– Shock acc. IEC 60068-2-27	3 axis, 15 g half sine, 11 ms
Dimension (W x D x H)	165 x 125 x 125 mm
Clearances – Above/Below	80 mm (3.15 in)
– Sides	10 mm (0.39 in)
Weight	2.8kg

See Approvals Table, page 6

Ordering Data

Type	Part No.
CP T SNT 180W 48V 4A	1105850000

Type	Part No.
CP T SNT 360W 48V 7.5A	1105860000

Type	Part No.
CP T SNT 600W 48V 12.5A	1105870000

\* See Graph B, page 8

\*\*See Graph A, page 8

**Redundancy Modules**

With a redundancy module and two PRO-H Series power supplies (of same type) you can configure a highly reliable, truly redundant power system without any additional components. This module enforces the equivalent sharing of the output current by each power supply. The system is fully redundant and provides output power even if one power supply has completely failed e.g. by short circuit on the output. In the event that either power supply fails or is disconnected, the second unit will automatically supply the full current to the load. The redundancy of the system is monitored and if lost, indicated by an alarm output. The inputs are hot swappable and can be loaded up to 15 A each.

**CP T RM 10 Redundancy Module**



**CP T RM 20 Redundancy Module**



**Technical Data**

**Input Specifications**

Input  
Input current

**Output Specifications**

Output voltage  
Output voltage adj. range  
Output power max.  
Output current

**General Data**

Status indicator  
Operating temperature

Redundancy OK signal (Alarm)

MTBF in acc. To IEC 61709

Alarm relay contact

Environment - Vibration  
- Shock

Dimension (W x D x H)

Weight

Remote link cable (0.5m)

Remote On/Off

Approvals

2 x 24 VDC  
15A

24 VDC  
24-27 VDC  
360 W  
15A @ 24VDC, @ 40°C

LED  
- 25 °C to 70 °C max. (-13 °F...+158 °F)  
derating above 40 °C (104 °F): 1.5 %/K  
trigger threshold at 18...22VDC,  
contact open if both inputs failed  
>350,000 hours, max. load  
30VDC/1A  
3 axis, sine sweep, 10...55Hz, 1g, 1oct/min.  
3 axis, 15g half sine, 11ms  
35 x 110 x 110 mm  
0.5kg  
2 cables included  
by ext. contact: contact open = On,  
contact closed = Off

See Approvals Table, page 6

2 x Control Input  
25A

24 VDC  
24-27 VDC  
600 W  
25A @ 24VDC, @ 40°C

LED  
- 25 °C to 70 °C max. (-13 °F...+158 °F)  
derating above 40 °C (104 °F): 1.5 %/K  
trigger threshold at 18...22VDC,  
contact open if both inputs failed  
>350,000 hours, max. load  
3 axis, sine sweep, 10...55Hz, 1g, 1oct/min.  
3 axis, 15g half sine, 11ms  
54 x 110 x 110 mm  
0.7kg  
2 cables included  
by ext. contact: contact open = On,  
contact closed = Off

See Approvals Table, page 6

**Ordering Data**

Type	Part No.
CP T RM 10	1105880000

Type	Part No.
CP T RM 20	1105890000

**Function Diagram**

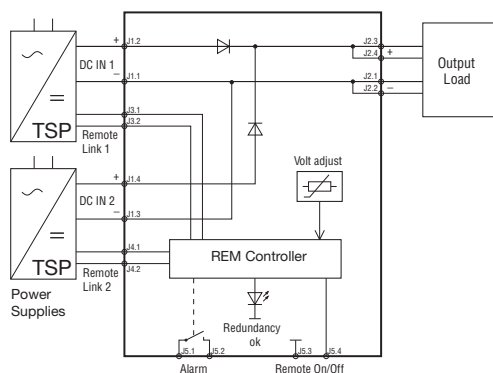

**Connector Positions**

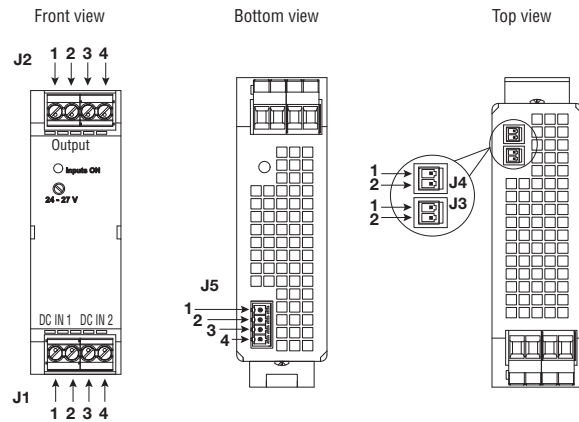

	J1	J2	J3 Voltage Control 1 For Input 1	J4 Voltage Control 2 For Input 2	J5
Pin 1	Input 1 -Vin	GND (-)	S+	S+	DC-OK Signal
Pin 2	Input 1 +Vin	GND (-)	S-	S-	DC-OK Relay Contact
Pin 3	Input 2 -Vin	Vout (+)	-	-	Remote ON/OFF
Pin 4	Input 2 +Vin	Vout (+)	-	-	Remote ON/OFF

For detailed installation instructions, please visit [www.weidmuller.com/power\\_supplies](http://www.weidmuller.com/power_supplies) and download LIT0917

Agency Approvals

UL file E236157	cULus Listed to UL508, CSA C22.2 No. 14
UL file E255651	cRUus to ANSI/UL60950, CSA60950
CSA file 246286	CSA to C22.2 No. 107.1
CSA file 246286	cCSAus to CSA60950, ANSI/UL60950
CSA file 246286	cCSAus C1D2 to C22.2 No. 213, UL1604, Group A, B, C, D
CSA file 246286	cCSAus C1Z2 to CSA60079-15, UL60079-15 & ANSI/ISA 12.012.01, Ex nC IIC T4U, Aex nC IIC T4U
IEC file SI-1729 B3	CE marked
LCIE file 10 ATEX 1015U	Ⓔ to EN60079-0, EN60079-15 (Ex nAC IIC T4 or T5 with derating)

CP T SNT 70W 12V 6A  
CP T SNT 90W 24V 3.8A

Weight: 0.5kg (1.0lb)

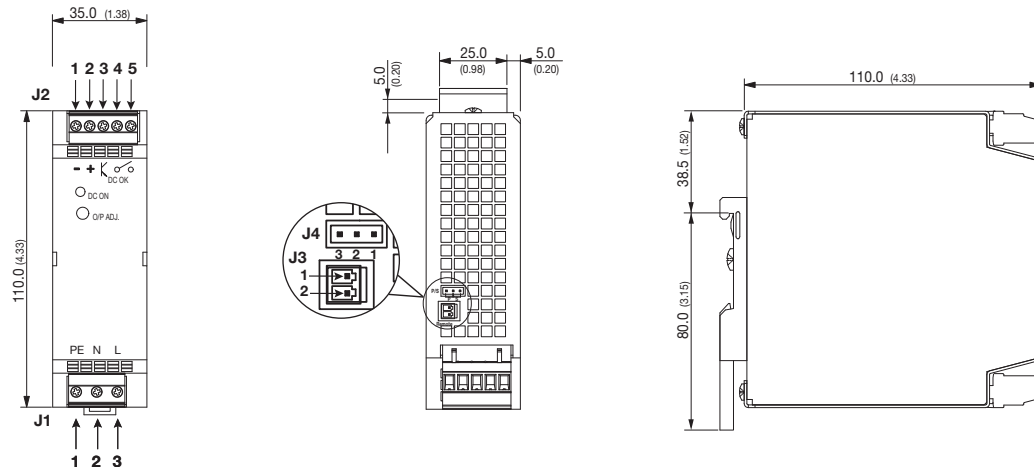

	J1	J2	J3	J4
Pin 1	Earth	GND (-)	S+	Normal Mode
Pin 2	Neutral	Vout (+)	S-	Common
Pin 3	Live	DC-OK Signal	-	Parallel Mode
Pin 4	-	DC-OK Relay Contact 1	-	-
Pin 5	-	DC-OK Relay Contact 2	-	-

CP T SNT 140W 12V 12A  
CP T SNT 180W 24V 7.5A  
CP T SNT 180W 48V 4A

Weight: 0.7kg (1.4lb)

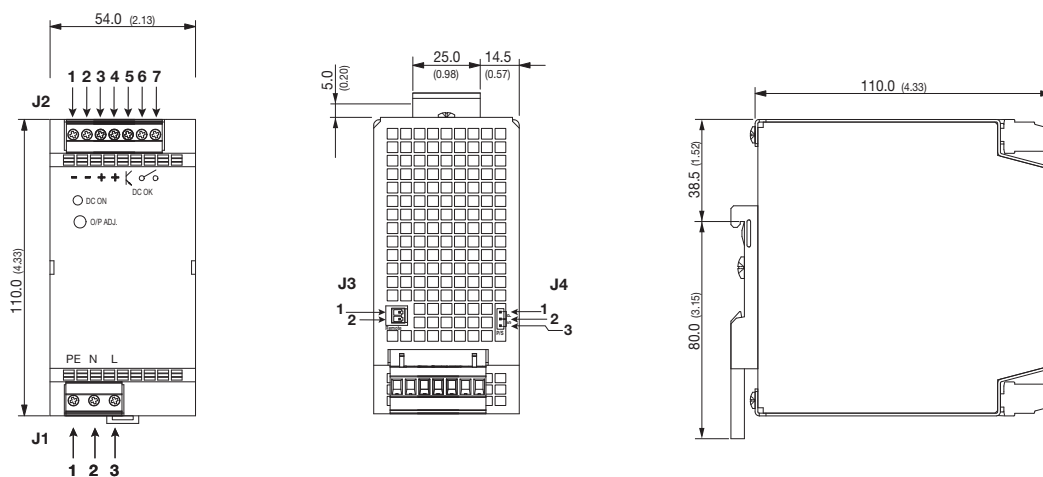

	J1	J2	J3	J4
Pin 1	Earth	GND (-)	S+	Normal Mode
Pin 2	Neutral	GND (-)	S-	Common
Pin 3	Live	Vout (+)	-	Parallel Mode
Pin 4	-	Vout (+)	-	-
Pin 5	-	DC-OK Signal	-	-
Pin 6	-	DC-OK Relay Contact 1	-	-
Pin 7	-	DC-OK Relay Contact 2	-	-

Dimensions in [mm], ( ) = inch  
Tolerances: ±0.5 mm (±0.02)

For detailed installation instructions, please visit [www.weidmuller.com/power\\_supplies](http://www.weidmuller.com/power_supplies) and download LIT0917

CP T SNT 360W 24V 15A  
 CP T SNT 360W 48V 7.5A

Weight: 1.1kg (2.4lb)

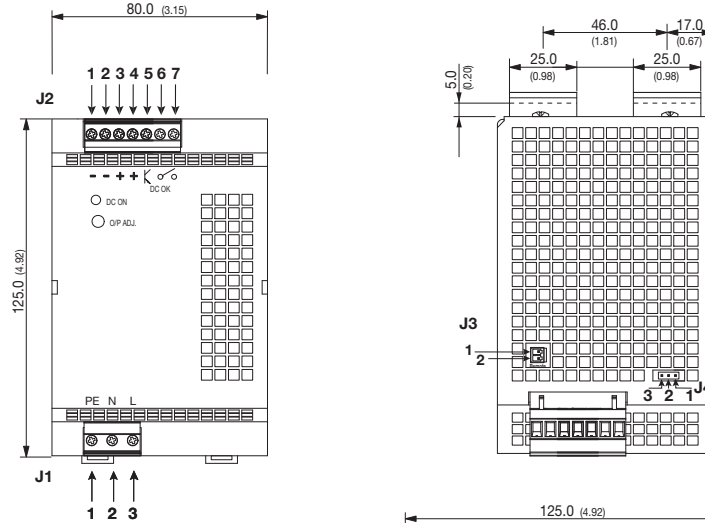

	J1	J2	J3	J4
Pin 1	Earth	GND (-)	S+	Normal Mode
Pin 2	Neutral	GND (-)	S-	Common
Pin 3	Live	Vout (+)	-	Parallel Mode
Pin 4	-	Vout (+)	-	-
Pin 5	-	DC-OK Signal	-	-
Pin 6	-	DC-OK Relay Contact 1	-	-
Pin 7	-	DC-OK Relay Contact 2	-	-

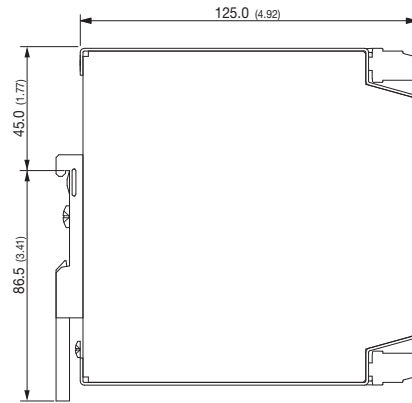

CP T SNT 600W 24V 24A  
 CP T SNT 600W 48V 12.5A

Weight: 2.8kg (6.0lb)

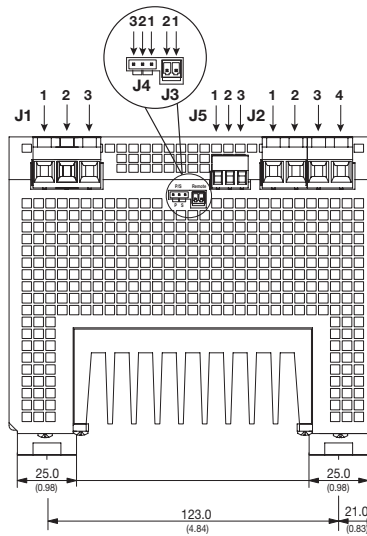

	J1	J2	J3	J4	J5
Pin 1	Earth	GND (-)	S+	Normal Mode	DC-OK Relay Contact 1
Pin 2	Neutral	GND (-)	S-	Common	DC-OK Relay Contact 2
Pin 3	Live	Vout (+)	-	Parallel Mode	DC-OK Signal
Pin 4	-	Vout (+)	-	-	-

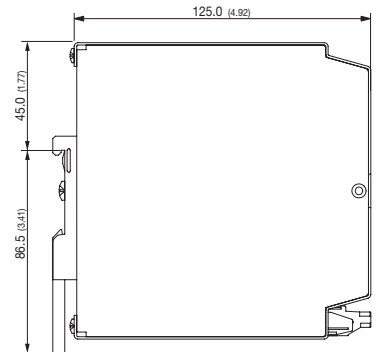
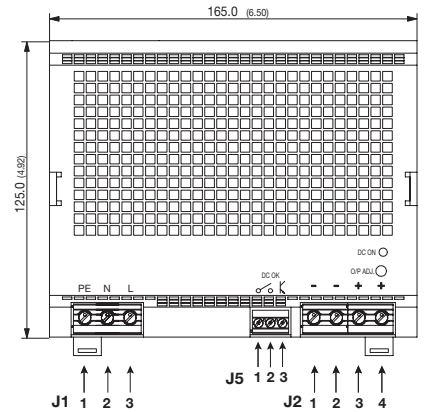

Dimensions in [mm], ( ) = inch  
 Tolerances: ±0.5 mm (±0.02)

For detailed installation instructions, please visit [www.weidmuller.com/power\\_supplies](http://www.weidmuller.com/power_supplies) and download LIT0917



Power Supplies  
Output Power Derating

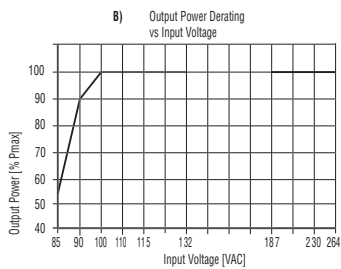
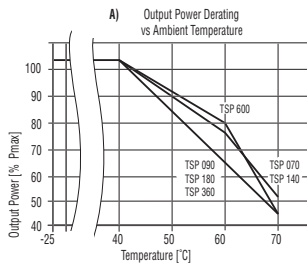

Wall Mounting Bracket

Ordering Data	Type	For Models	Content of Kit
1129210000	CP MB01	CP T SNT 70W, 90W, 140W, 180W	1 bracket type A
1129220000	CP MB02	CP T SNT 360W, 600W	2 brackets type B

Type A:

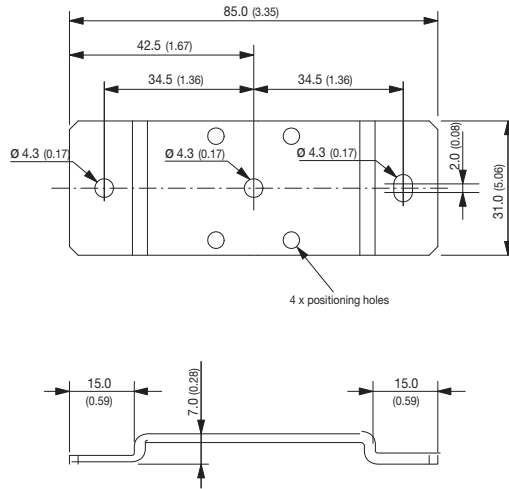

Material: 2 mm Mild Steel  
Tolerance: ±0.1mm (± 0.004)

CP T SNT 70W, 90W

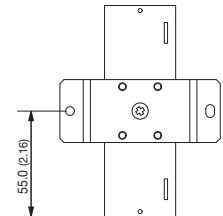

CP T SNT 140W, 180W

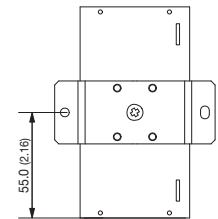

Trip Curve

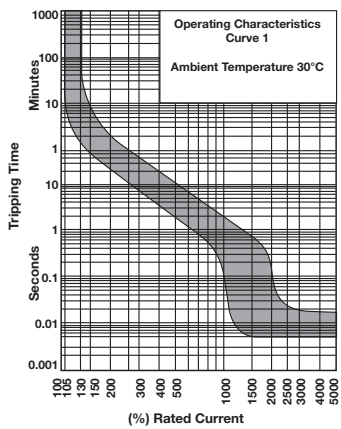

Type B:

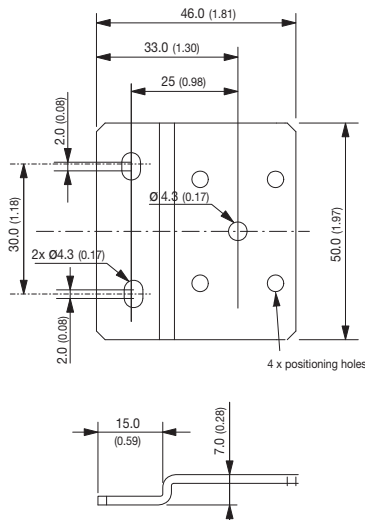

Material: 2 mm Mild Steel  
Tolerance: ±0.1mm (± 0.004)

Dimensions: [mm] ( ) = Inch

CP T SNT 360W

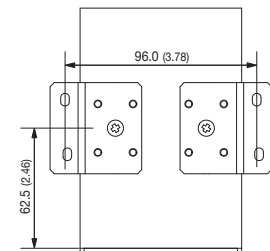

CP T SNT 600W

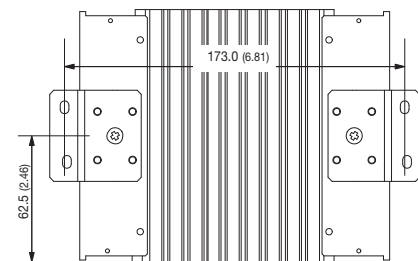

For detailed installation instructions, please visit [www.weidmuller.com/power\\_supplies](http://www.weidmuller.com/power_supplies) and download LIT0917